

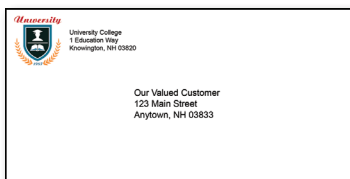

AP2

MONOCHROME DIGITAL ADDRESS PRINTER

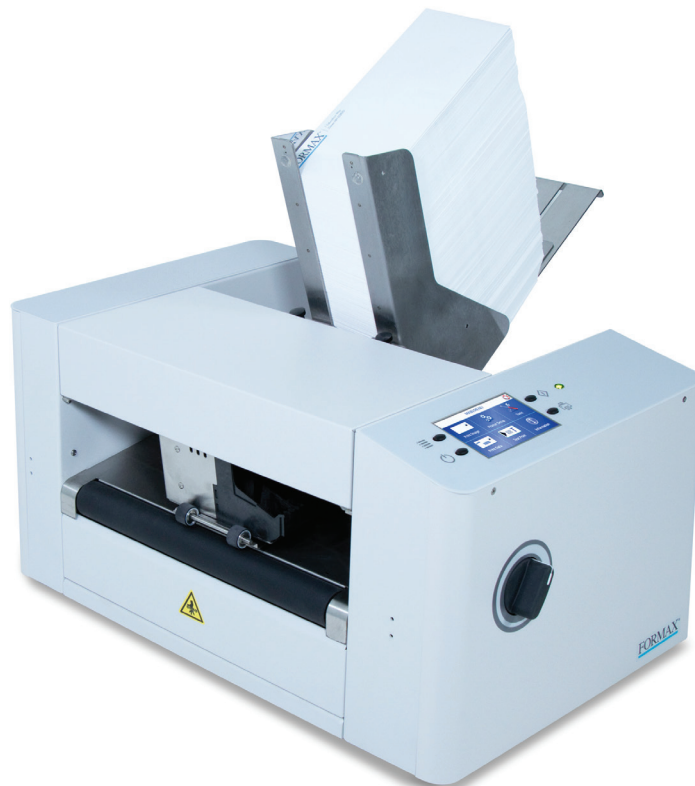
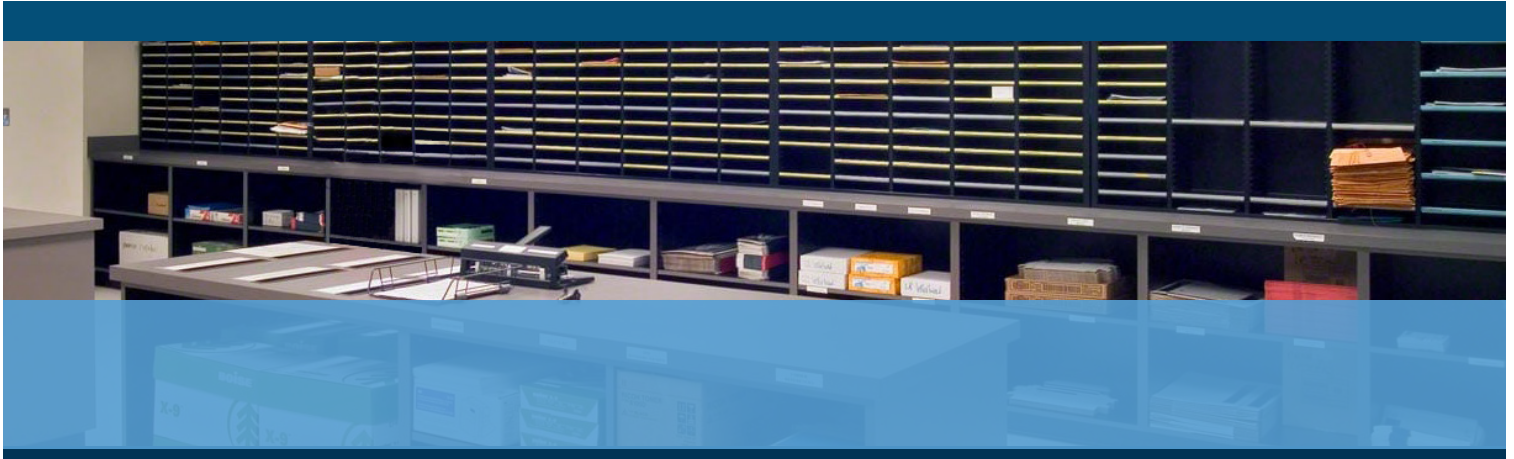

Imaging area up to 2" x 15" is ideal for printing outgoing address on envelopes with pre-printed return address

- Prints up to 22,000 #10 envelopes per hour
- 4-pen stitched single-head design
- Imaging area up to 2" H x 15" L
- Up to 600 x 600 DPI
- Duty cycle up to 500,000 per month

FORMAX[®]

www.formax.com

Local Dealer:

The **AP2 Digital Address Printer** produces **up to 22,000 envelopes per hour** with variable **print resolutions up to 600 DPI**. Its **4.5" color touchscreen** allows users full control of functions, including storing and recalling common print jobs, **up to 16GB**. The **integrated feeder** holds up to 500 envelopes at a time, and can handle materials **up to 1/4" thick**. The fixed print head uses **4 high-capacity thermal inkjet cartridges**, producing an **image area up to 2" x 15"**, and can be adjusted to a vertical print range up to 10.75". Features include **on-screen ink monitoring, USB 3.0/LAN connectivity, TrueType compatibility, spot color capability, and batch/job/lifetime counters**.



User-Friendly Touchscreen
Color touchscreen with adjustable backlight and easy navigation

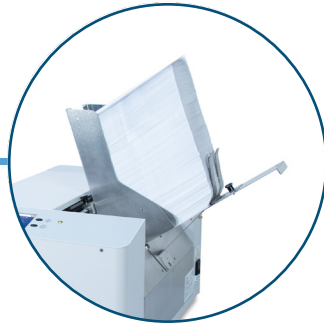

Integrated Envelope Feeder
Holds up to 500 envelopes and can be refilled on the fly

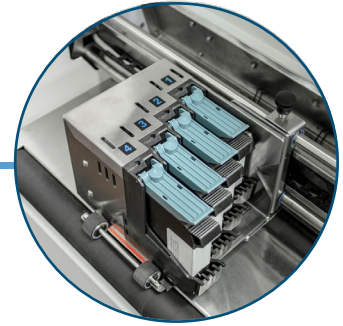

4-Pen Stitched Single-Head Design
Uses 4 high-capacity thermal inkjet cartridges

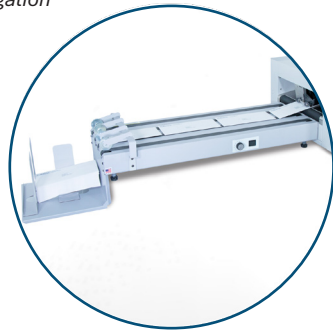

Optional Conveyor/Stacker
3-foot conveyor/stacker with tabletop legs and catch tray

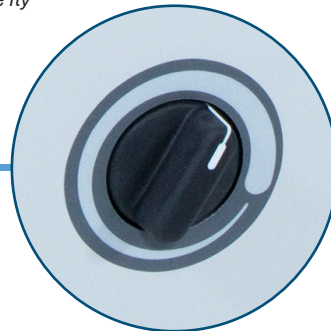

Adjustable Print Head Height
Adjustable to accept media up to 1/4" thick using the dial on the side

STANDARD FEATURES

- 4.5" color touchscreen
- Prints up to 22,000 #10 envelopes/hour
- Fixed, 4-pen stitched single-head
- Job memory up to 16GB
- Integrated feeder, up to 500 envelopes
- Variable print resolution, up to 600 DPI
- Batch, job, and lifetime counter
- On-screen ink monitor
- Uses 4 high-capacity inkjet cartridges
- One-pass printing
- Image area up to 2" H x 15" L
- TrueType enabled
- Spot color: blue, red, green, invisible
- Prints on coated and uncoated stocks

OPTIONS

- AP-05 3-foot Bi-Directional Conveyor/Stacker
- Bulk Mailer Software
- Thermal Inkjet Cartridges

SPECIFICATIONS

Print Technology	Thermal inkjet, 4 high-capacity cartridges*
Addressing Speed	Up to 22,000 #10 envelopes/hour Up to 30,000 postcards/hour
Print Quality	Up to 600 x 600 DPI
Imaging Area	Up to 2" H x 15" L (51 x 381mm)
Material Size	Min: 5" L x 3" W (127 x 76mm) Max: 15" L x 13.5" W (381 x 343mm)
Material Thickness	Up to 6.3mm / 1/4"
Duty Cycle	Up to 500,000 per month
Memory	Up to 16GB
Print Head Layout	4 pen stitched design
Fonts	All True Type fonts available on PC
Feeder Capacity	Up to 500 #10 envelopes
Print Orientation	Right to left
Software	Driver for Windows 7 and higher
PC Interface	USB 3.0, Ethernet
Dimensions	23" L x 22" D x 19" H (58 x 56 x 48cm)
Weight	60lbs (27kg)
Power	115VAC 50/60 Hz

* Printer ships with 4 AP22 high-capacity ink cartridges