

FORMAX[®]

FD / FE 8730HS
Paper/Optical Media Shredder

MAINTENANCE MANUAL
THIRD EDITION

TABLE OF CONTENTS



TOPIC	PAGE
Specifications	1
Set-up Guidelines	1
Control Panel	1
Operation	2
AutoOiler Operation	2
Safety Devices & Other Features	2
Safety Precautions	3
Daily Maintenance	3
Auto Cleaning	3
Sensor Sensitivity Recovery	4
Removing Motor & Cutting Head Unit	4
Replacing Door Hinges	4
Replacing Casters	5
Repairing Motor Condenser & Contactor	5
Replacing Oiler Reservoir Bottle	6
Troubleshooting	6-7
Parts Lists	8-13

Specifications

Not for use with staples or paper clips they will damage the cutting blades

	Paper	Optical media
Cutting Style:	Cross Cut	Cross Cut
Shred Size:	1/32" x 3/16"	1/16" x 5/32"
Sheet Capacity:	14 - 15 sheets*	1 CD
1-Hour NSA Durability Test:	19 reams/feeding 8 sheets	
Speed:	23 fpm	2,000 CDs per hour
Feed Opening	9 3/8"	4 7/8"
Bin Capacity	31 gal.	18.5 gal.
Security Level	Level 6	
Dimensions:	28" W x 24" D x 43" H	
Weight:	319 lbs.	
Power Supply:	110V, 50/60 Hz 15 Amp	
Does Not accept credit cards, staples or paper clips		
*Capacity varies depending on paper and power supply		

Set-up Guidelines

1. Install the shredder on a level surface, away from heat sources and direct sunlight.
2. Insert plug into wall outlet with the appropriate voltage, 110V. If the outlet is shared with another electronic device, the total current should not exceed 30A (at 110V).

Control Panel Functions

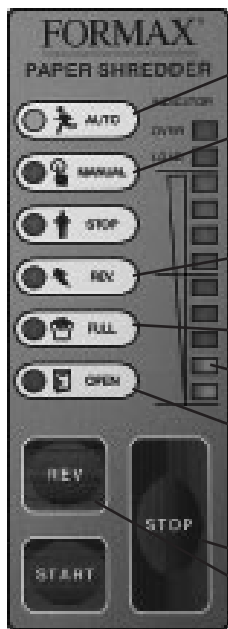

AUTO: The shredder will operate in Auto mode after pressing the Start button.

MANUAL: By pressing the Start button a second time, the shredder can be operated in Manual mode. The shredder will begin running, and will stop automatically after 3 minutes.

REV: The shredder will automatically reverse cutter direction if too many sheets of paper are inserted at one time.

FULL: The shredder automatically stops when the waste bin is full.

LOAD INDICATOR: This multi-colored indicator shows the load during shredding.

OPEN: The shredder will stop automatically if the cabinet door is open. Simply close the door and press Start to resume operation.

STOP: Pressing this button stops operation.

REV. BUTTON: Pressing this button reverses the cutting blades.

Control Panel

Operation

1. Flip the power switch “ON” located on the right side of the shredder.

2. Auto Start/Auto Stop

When the START button is pushed, the signal lamp “AUTO” will light. Insert paper to shred. The shredder will start and stop automatically when using this function.

3. Manual Operation

If paper is too small for the shredder’s sensors to detect, shred it manually. Push the START button once more and the “MANUAL” lamp will light. Insert paper to be shredded. Three minutes after shredding, the cutter automatically stops rotating.

4. Reverse Operation

Push the REV button and the signal lamp “REV” will light and cutters will operate in reverse. If too much paper is inserted at one time in standard modes, the shredder will automatically operate in reverse. If this occurs, remove the inserted paper and shred in smaller amounts. NOTE: The maximum amount of paper to be shredded differs according to paper quality, humidity and voltage. If the shredder is to be used continuously, do not insert more than half of the maximum capacity.

5. Full Sensor

If the waste bin is full, the “FULL” lamp will light and the cutter will stop automatically. Open the door, empty the waste bin of paper scraps, replace the waste bin, close door, and continue to shred.

AutoOiler

The AutoOiler pumps 20 ml of oil onto the cutting head every 30 minutes to help keep the FD 8650CC working at peak performance.

1. Fill oil reservoir with recommended shredder oil.
2. Insert hose into the top of the bottle.
3. The oiler is ready for use.

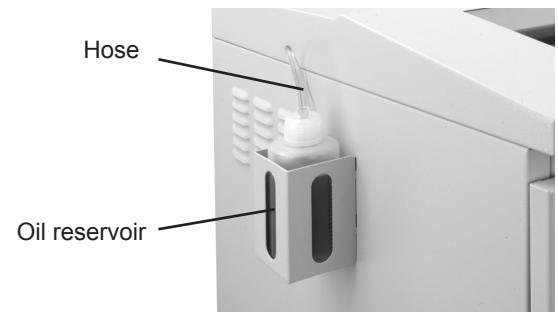

Safety Devices & Other Features

Automatic Reverse Rotation

When too much paper is inserted, the cutter stops operating and automatically rotates in reverse to discharge the jammed paper. An alarm sounds. Remove the jammed paper and reduce the size of the stack, then restart the operation.

Door Switch

If the door is open, the shredder will not operate.

Automatic Stop

When the waste bin is full of shredded paper, the “FULL” LED will light comes on and the cutter stops operation. Open the door, remove the waste bin and empty paper scraps. Replace the waste bin, close the door and continue operation.

Automatic Power Shut-Off

- If the shredder operates continuously for more than 30 minutes, the power is automatically shut off.
- If the motor is overloaded, the “STOP” LED will flash until it cools down. When the flashing stops the shredder is ready to be used again.

Safety Precautions

To avoid personal injury, and damage to the shredder, observe the following safety precautions. Please keep these instructions for future reference.

NOTE: In case of emergency, flip the circuit breaker to cut off power and/or pull the plug out of the wall outlet.

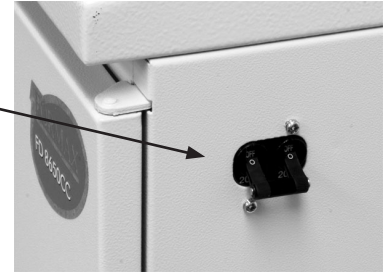

- Keep hands, long hair, clothing, ties, jewelry and loose items away from the feed opening and shred outlet.
- Do not use the shredder for anything other than its intended purpose. Never use it to shred cloth, plastic, cardboard or any hard material that will cause damage to the shredder blades.
- Do not allow children to use the machine.
- Do not operate with a damaged power cord or plug, or when the machine is damaged in any manner.
- Unplug the shredder when it is being moved, or if it is not in use for an extended period of time.
- Do not disconnect the power by pulling only the cord. Hold the plug when disconnecting.
- Keep the shredder away from direct sunlight.
- Do not sit on the shredder or place anything on top of it.
- Never open the fixed switch or cover.

Daily Maintenance

- Disconnect power by removing the power cord plug from wall outlet.
- To clean the exterior, wipe the surface with a soft cloth. If the surface is very dirty, use a neutral detergent, then wipe again with a soft cloth.

CAUTION:

- Never put water directly on the surface of the shredder.
- Never clean the case with benzene or thinner, since it will cause discoloration.
- Do not dismantle the shredder. Contact your Formax Dealer for service.

Auto Cleaning Function

Use the Auto Cleaning function when sheet capacity is decreased.

1. Prior to using the Auto Cleaning function, spread shredder oil onto the cutters through the feed opening, and allow the oil to sit for a few minutes to permeate the cutting blades.
2. Press the REV button and hold for five seconds. Manual and Rev LED indicators on control panel will light.
3. The shredder will operate in reverse for one minute, then the Auto LED will light.

Sensor Sensitivity Recovery Function

Over time, the shredder photo eye may lose its sensitivity. Use the following steps to reset the sensor's sensitivity.

1. If the sensor cannot detect paper:
 - Press the Stop button for five seconds.
2. If the shredder is operating without paper in the feed opening:
 - Press stop, then insert paper into the feed opening and press the Stop button for five seconds.

After following either of these steps, all LED lamps should be off, and the shredder will make a beep sound. Sensitivity is recovered and the shredder is ready to operate. Follow instructions under Operation.

Removing Motor & Cutting Head Unit

To remove the motor and cutting head unit for servicing:

- Open front door, remove screws connecting lid to body case.
- Unplug cables and remove lid; set aside.
- Remove waste bin; set aside.
- Using a 12mm socket, remove four nuts on under side (see Figure 1).
- Carefully lift out motor/cutting head unit from the top.
CAUTION: Heavy.



Figure 1

Replacing Door Hinges

If the door is separated from the body housing, replace the upper and/or lower hinge, (Figures 2 and 3).

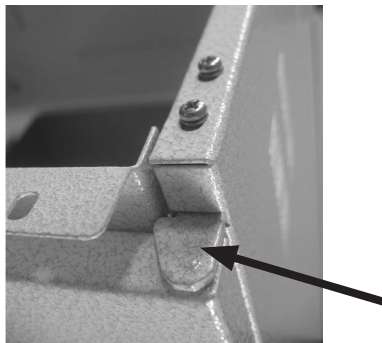

Figure 2, top hinge

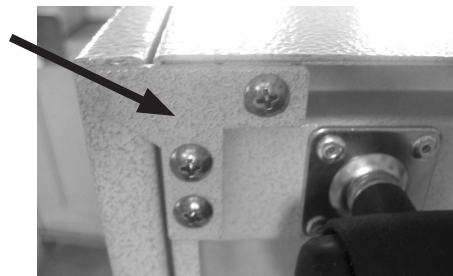

Figure 3, bottom hinge

Replacing Casters

If casters are damaged, remove rivets and attach new casters with screw bolts (Figure 4).

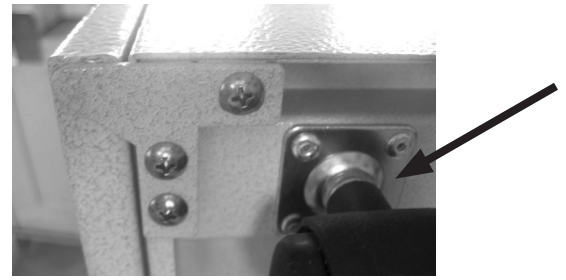
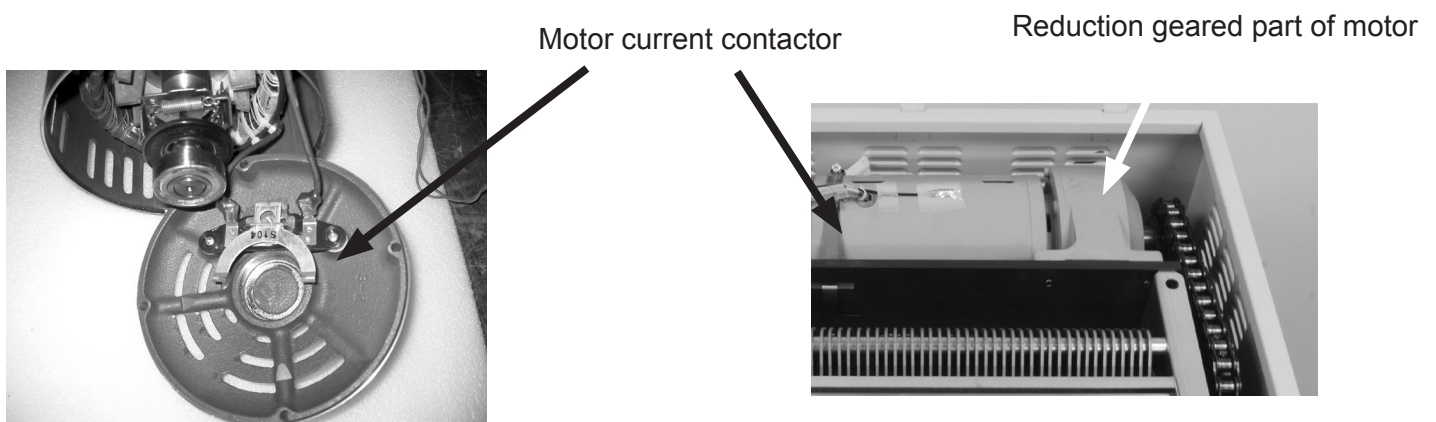

Figure 4, caster

Repairing Motor Condenser & Contactor

If the motor doesn't work, the motor condenser or motor current contactor could be damaged. Open the motor cover, clean the contactor and adjust the gap of contactor.

Alternately, replace the motor condenser.



Replacing Oiler Reservoir Bottle

When the oiler bottle is empty, follow one of these two procedures.

Using same oil bottle:

1. Unscrew cap and remove hose and cap from bottle.
2. Fill oil bottle with recommended shredder oil.
3. Replace cap and hose.

Using replacement oil bottle:

1. Unscrew cap and remove hose and cap from bottle.
2. Remove empty bottle from bracket.
3. Insert new filled bottle into bracket, remove cap.
4. Replace cap and hose into new bottle.

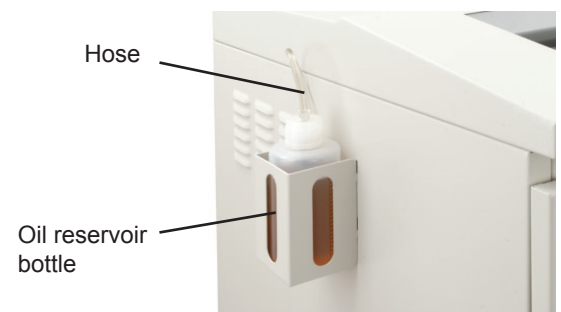

TROUBLESHOOTING

PROBLEM:	CHECK THIS:	SOLUTION:
Shredder will not operate	Check that the power cord is plugged into an appropriate outlet	Plug cord into outlet
	Check voltage of power outlet	If necessary, find an alternate outlet with the appropriate voltage
	Check the wiring between the fuse connector on the PCB (page 12)	Reconnect, if necessary
Shredder capacity is decreased		Follow directions for Auto Cleaning, page 4
Main power is functioning but shredder won't operate (Main PCB)	Check main power cable (page 12) to see if it is properly connected to the Main PCB (page 12)	Reconnect, if necessary
	Check the Main PCB's printed circuit and wire disconnection of transformer	If there is a problem with the circuit and/or transformer, replace with new one
	Check the electrical contacts on the main control switch	Reconnect, if necessary
Main power is okay, but shredder is not working (electrical) NOTE: Photo sensor should be connected with the main PCB during testing.	Check the outlet for correct voltage, 120V	Use different outlet, if necessary
	Check wire connection between photo sensor and Main PCB (pages 11 & 12). If there is no output signal from Main PCB, shredder will not operate.	Reconnect cable to sensor and Main PCB
	Photo sensor could be dirty	Remove photo sensor (page 11) and clean it with a soft cloth
	Photo sensor sensitivity may need to be reset	Sensitivity measurement distance should be .4 inch (10mm). If distance is less than .4 inch, replace the photo sensor
	Check power relay contacts	Reconnect, or replace main PCB power relay if necessary. If printed circuit is damaged, replace the main PCB.
Main power is okay, but shredder is not working (mechanical)	Check motor current contactor	Open motor cover, clean contactor and adjust gap of contactor (page 5)
	Shredder may have overheated.	Wait 5-10 minutes for motor to cool down, then resume shredding
	Check motor condenser for damage	Replace motor condenser

Shredder motor and blades continue to rotate	Check control panel lights to see if AUTO lamp is flashing	If so, follow instructions for Sensor Sensitivity Recovery (page 4)
	Check control panel lights to see if MANUAL lamp is on	If yes, press the START button. AUTO lamp should light and shredder should operate in AUTO mode.
	Photo sensor could be dirty	Remove photo sensor (page 11) and clean it with a soft cloth
	Photo sensor sensitivity may need to be reset	Sensitivity measurement distance should be .4 inch (10mm). If distance is less than .4 inch, replace the photo sensor
	Check power relay contacts	Reconnect, or replace main PCB power relay if necessary
Reverse function will not work	Check power relay contacts (in case of electrical coil damage)	Replace power relay
	Check printed circuit for damage	If damaged, replace the Main PCB
Shredder makes an unusual or metallic noise	Check cutters for materials lodged between cutting blades and/or guides	If so, turn off shredder and carefully remove any foreign materials from the cutter. Then follow instructions for Auto Cleaning (page 3)
	Check guides and cutters for damage (pages 9)	If guides and/or cutters are broken, the whole cutting head should be replaced
	Check bearings, space rings and cutting shafts for damage (pages 9)	If any of these parts are damaged, they should be replaced, in addition to side plates
Motor makes a "tick tick" noise	Check the reduction gears for damage (page 5)	If the reduction gears are broken, replace the entire motor

PARTS LISTS

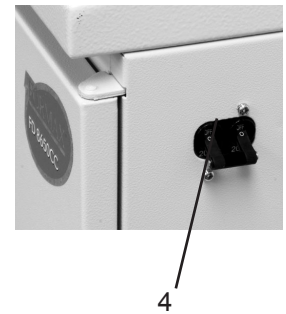
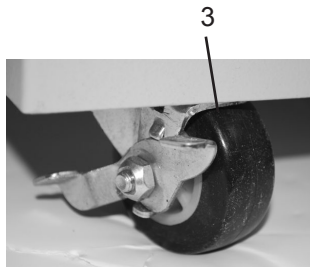
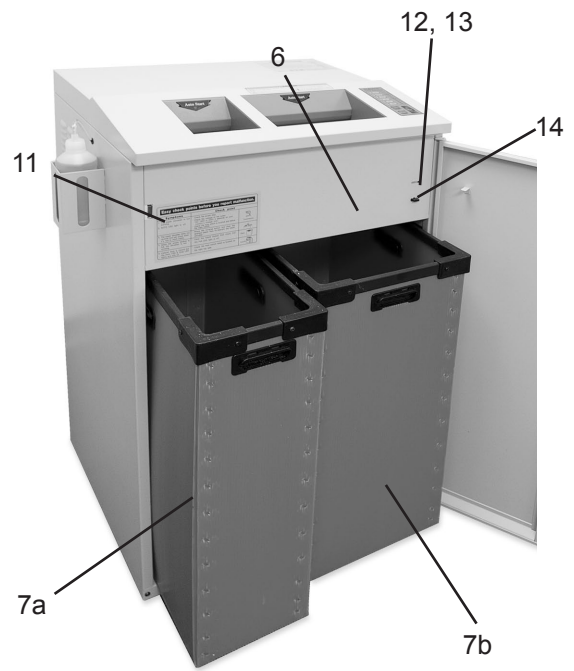
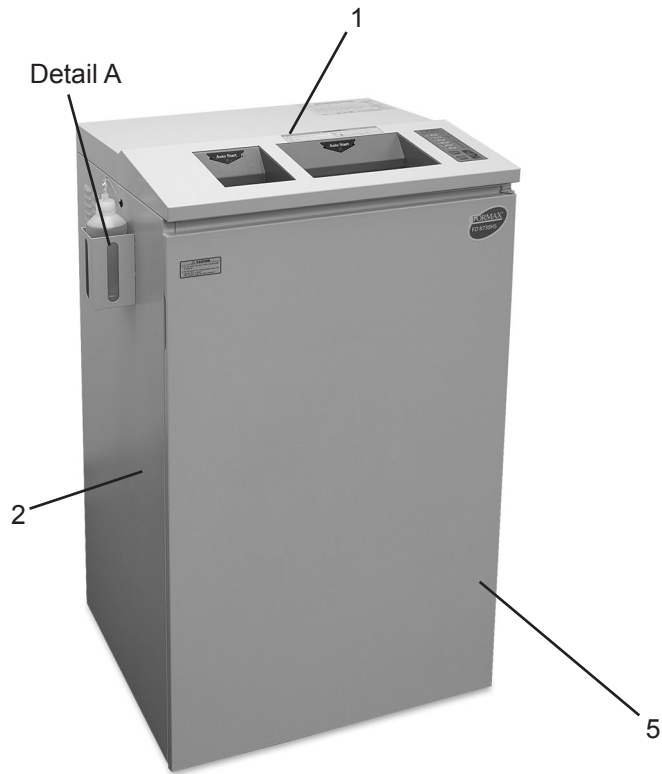

ITEM	PART #	DESCRIPTION	QTY
*	FD8730CC-CAS-00	TOP COVER ASSEMBLY	1
1	FD8730CC-CAS-01	TOP COVER (OUTER)	1
2	FD8730HS-CAS-05	BODY CASE ASSEMBLY	1
3	FD8730HS-CAS-12	CASTERS	4
4	FD8730HS-PCB-07	CIRCUIT BREAKER	1
5	FD8730HS-CAS-15	DOOR	1
6	FD8730HS-CAS-14	FRONT COVER ASSEMBLY	1
7a	FD8730CC-CAS-13	WASTE BIN - OPTICAL MEDIA	1
7b	FD8730CC-CAS-19	WASTE BIN - PAPER	1
8	FD8730HS-OIL-05	OIL HOSE	1
9	FD8730HS-OIL-01	OILER BOTTLE	1
10	FD8730HS-OIL-02	OILER BOTTLE BRACKET	1
11	FD8730HS-CAS-17	DOOR MAGNET	1
12	FD8730HS-PCB-08	MICRO SWITCH, DOOR 15A	1
13	FD8730HS-PCB-06	DOOR / FULL SWITCH HARNESS	1
14	FD8730HS-PCB-11	DATA OUTPUT HARNESS	1

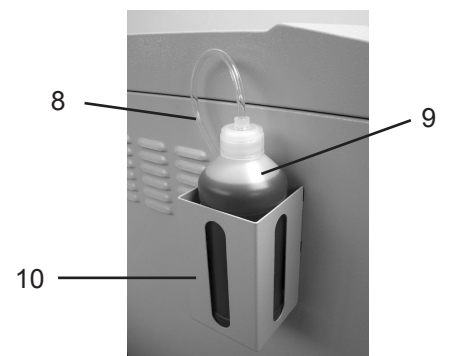

Detail A

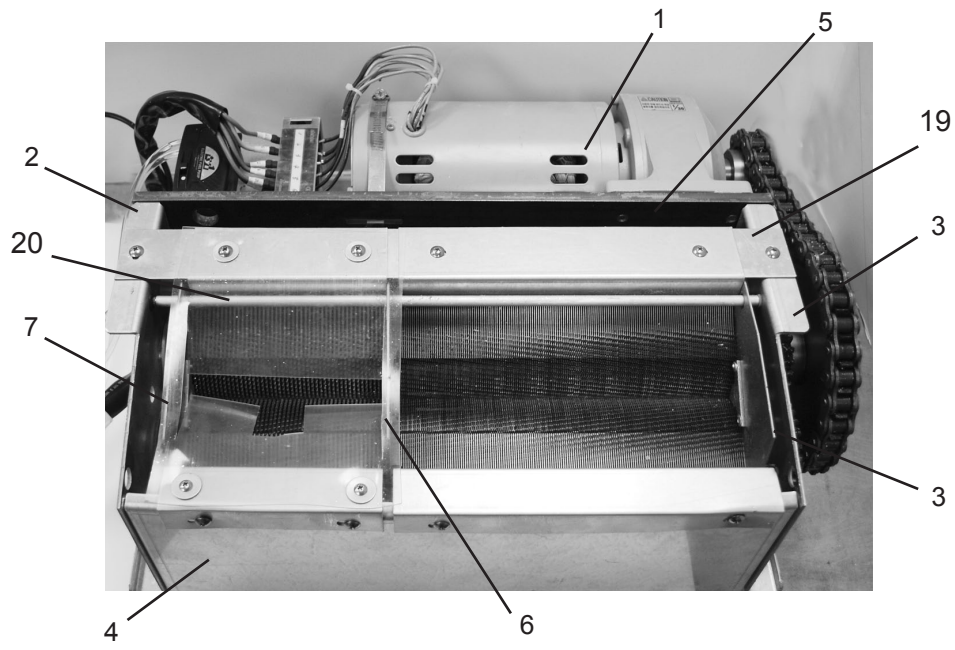

ITEM	PART #	DESCRIPTION	QTY
1	FD8730HS-CTB-03	MOTOR,750W	1
2	FD8730HS-CTB-04	SIDE PLATE, LEFT	1
3	FD8730HS-CTB-05	SIDE PLATE, RIGHT	1
4	FD8730HS-CTB-07	CUTTER COVER	1
5	FD8730HS-CTB-08	MOTOR COVER	1
6	FD8730HS-CTB-09	GUIDE PLATES, CENTER	1
7	FD8730HS-CTB-25	GUIDE PLATE, LEFT	1
8	FD8730HS-CTB-26	GUIDE PLATE, RIGHT	1
9	FD8730HS-CTB-10	POST	2
10	FD8730HS-CTB-18	CUTTER BLADE	-
11	FD8730HS-CTB-19	GUIDE	-
12	FD8730HS-CTB-20	RING	-
13	FD8730HS-CTB-19	BEARING (6206NRZZ)	2
14	FD8730HS-CTB-23	SPACE RING ACETAL (5.0t)	-
15	FD8730HS-CTB-21	BEARING WASHER (AW 07)	1
16	FD8730HS-CTB-22	BEARING NUT (AN 07)	1
17	FD8730HS-CTB-15	LONG SHAFT	1
18	FD8730HS-CTB-16	SHORT SHAFT	1
19	FD8730HS-OIL-06	OIL NOZZLE BRACKET	1
20	FD8730HS-OIL-04	OIL NOZZLE	1
-	FD8730HS-CTB-01	CUTTING HEAD WITH MOTOR	-
-	FD8730HS-CTB-02	CUTTING HEAD WITHOUT MOTOR	-

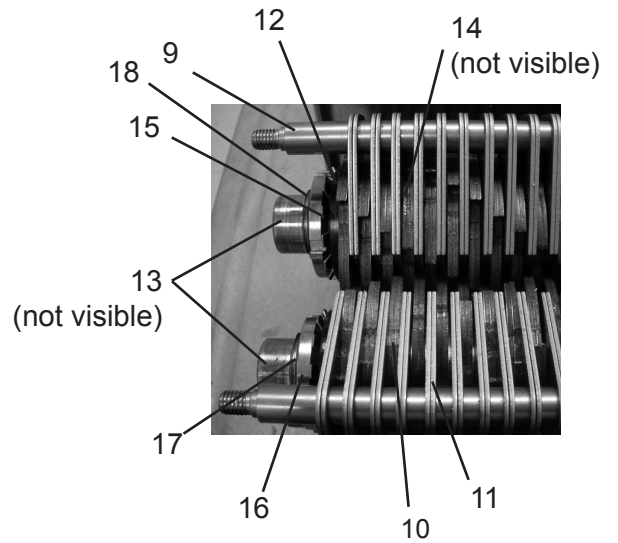

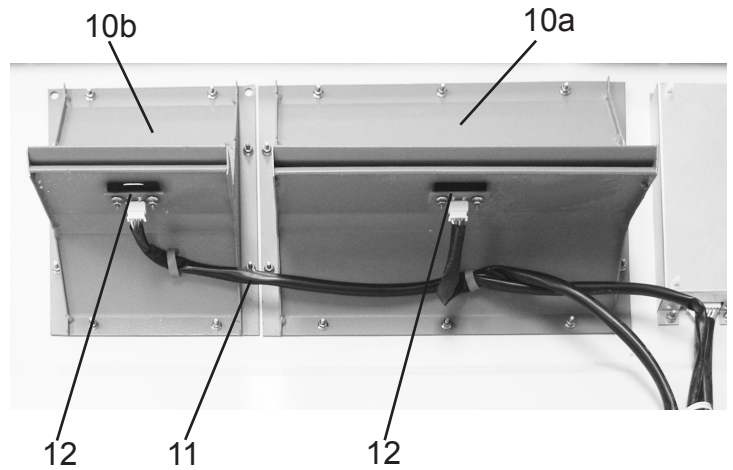
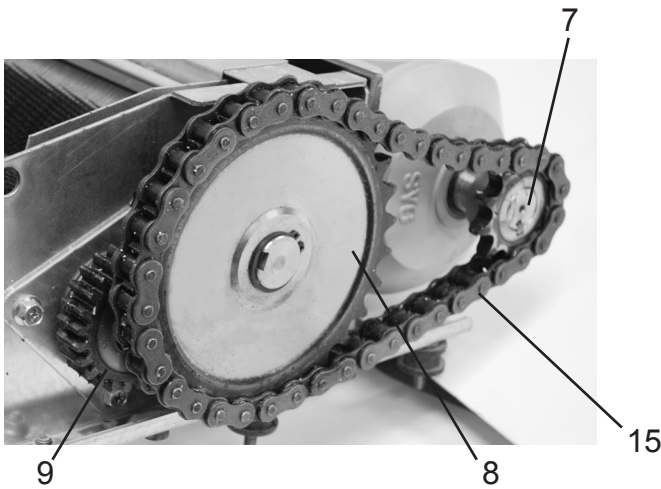
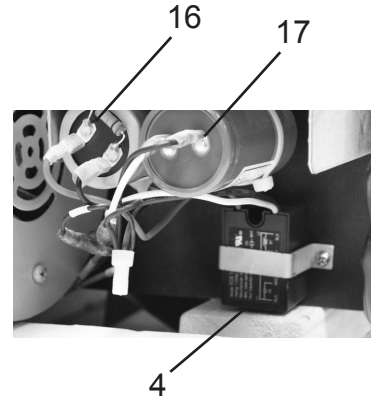
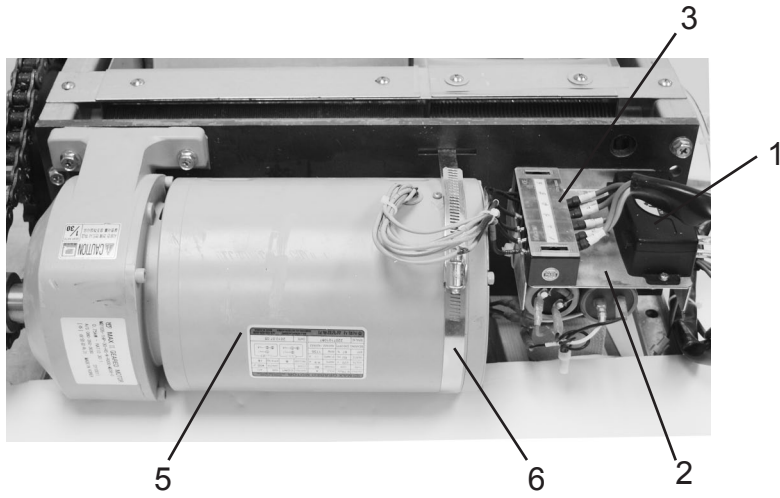

ITEM	PART #	DESCRIPTION	QTY
1	FD8650HS-OIL-03	OIL PUMP MOTOR	1
2	FD8730HS-OIL-07	OIL PUMP BRACKET	1
3	FD8730HS-PCB-12	6-TERMINAL BLOCK	1
4	FD8730HS-PCB-13	RELAY	1
5	FD8730HS-CTB-03	MOTOR 750w	1
6	FD8730HS-CTB-14	MOTOR BEND	1
7	FD8730HS-CTB-11	MOTOR SPROCKET	1
8	FD8730HS-CTB-12	CUTTER SPROCKET	1
9	FD8730HS-CTB-13	SPUR GEAR	1
10a	FD8730HS-CAS-02	INFEEED THROAT, PAPER	1
10b	FD8730HS-CAS-03	INFEEED THROAT, OPTICAL MEDIA	1
11	FD8730HS-PCB-01	SENSOR HARNESS	1
12	FD8730HS-SEN-01	PHOTO EYE	
13	FD8730HS-CAS-04	SWITCH COVER	1
14	FD8730HS-CAS-18	SUPPORT PIN (JOSS-6N)	4
15	FD8730HS-CHA-01	CHAIN #60	1
16	1HP-CTB-01	MOTOR STARTING CAPACITOR	1
16*	FE8730-CTB-01	MOTOR STARTING CAPACITOR, 220V (*FE model)	1
17	1HP-CTB-02	MOTOR RUNNING CAPACITOR	1
17*	FE8730-CTB-02	MOTOR RUNNING CAPACITOR, 220V (*FE model)	1
*	FD8730HS-CAS-09	SWITCH BRACKET	1

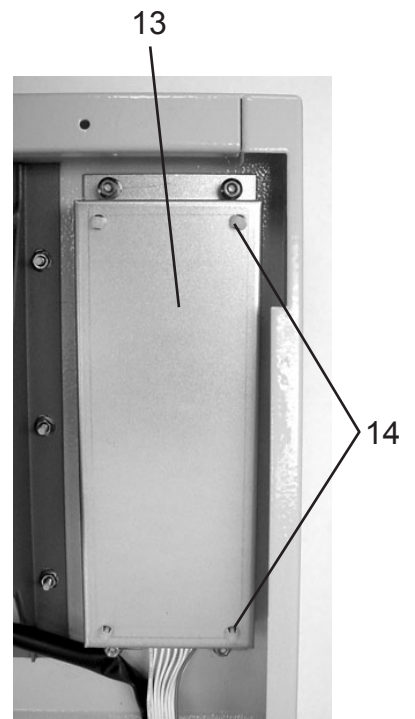

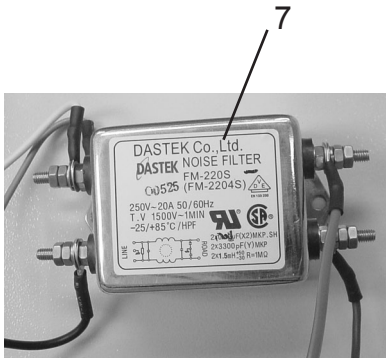
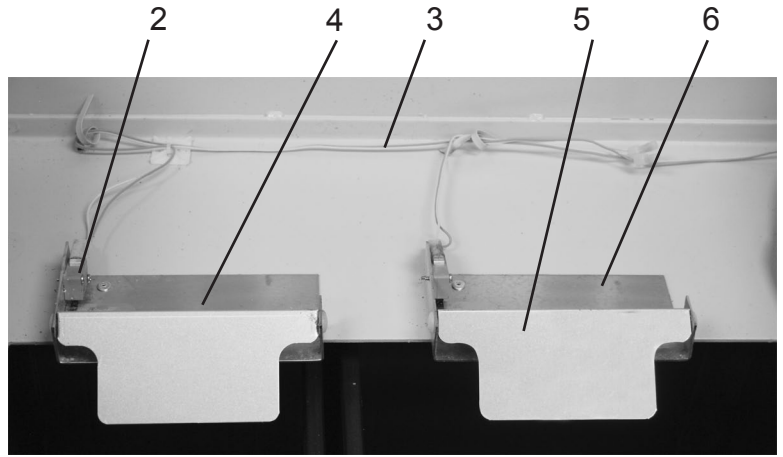
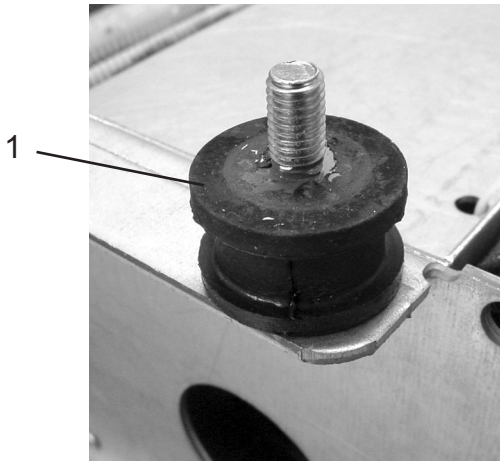

ITEM	PART #	DESCRIPTION	QTY
1	FD8730-RUB-01	VIBRATION-PROOF RUBBER (030)	4
2	FD8730-PCB-05	MICRO SWITCH (WASTE BIN) 5A	2
3	FD8730-PCB-06	DOOR/FULL SWITCH HARNESS	2
4	FD8730-CAS-07	WASTE BIN FULL SENSING, ASSY	2
5	FD8730-CAS-08	WASTE BIN FULL SENSING, PLATE	2
6	FD8730-CAS-09	WASTE BIN FULL SENSING, BRACKET	2
7	FD8730-FIL-01	NOISE FILTER	1

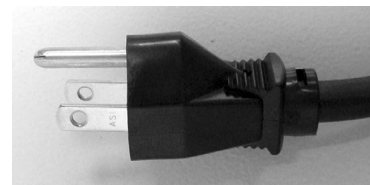
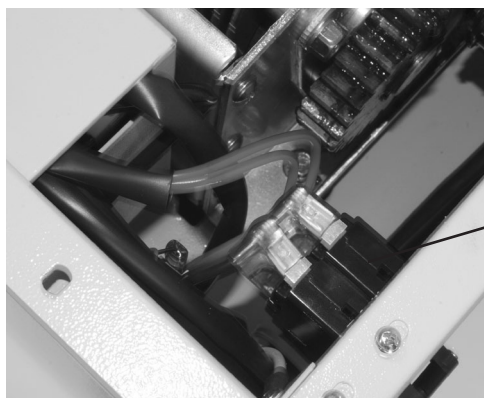
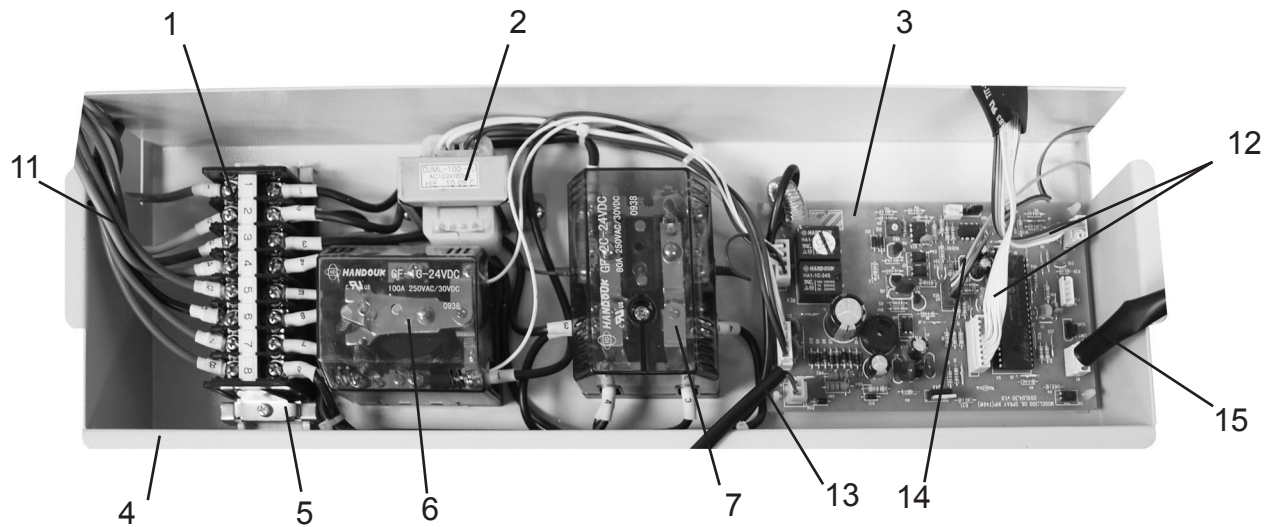

ITEM	PART #	DESCRIPTION	QTY
1	FD8730HS-PCB-14	8-TERMINAL BLOCK	1
2	FD8730HS-PCB-15	TRANSFORMER	1
2*	FE8730-PCB-06	TRANSFORMER, 220V (*FE model only)	1
3	FD8730HS-PCB-04	MAIN PCB BOARD	1
3*	FE8730-PCB-04	MAIN PCB KIT, 220V (*FE model only)	1
4	FD8730HS-CAS-16	MAIN PCB COVER	1
5	FD8730HS-PCB-16	TERMINAL BLOCK BRACKET	1
6	FD8730HS-PCB-18	RELAY (K1) 100A	1
7	FD8730HS-PCB-17	RELAY (K2) 80A	1
8	FD8730HS-PCB-07	CIRCUIT BREAKER	1
9	FD8730HS-PCB-03	POWER CORD	1
11	FD8730HS-PCB-10	MAIN HARNESS	1
12	FD8730HS-PCB-09	BODY HARNESS	1
13	FD8730HS-OIL-10	OIL PUMP HARNESS	1
14	FD8730HS-PCB-06	DOOR / FULL SWITCH HARNESS	1
15	FD8730HS-PCB-11	DATA OUTPUT HARNESS	1

