

FORMAX[®]

Square IT
Booklet Squareback Finisher

TITLE	PAGE
PARTS:	
Covers	4
Motors	6
Sensors	8
Interlock switches	10
Transport belts	12
Link arm assy front and rear	14
Stop gate cam	16
Roll motor	18
Electrical componets	20
Control panel	22
Outfeed and stacker	24

Covers

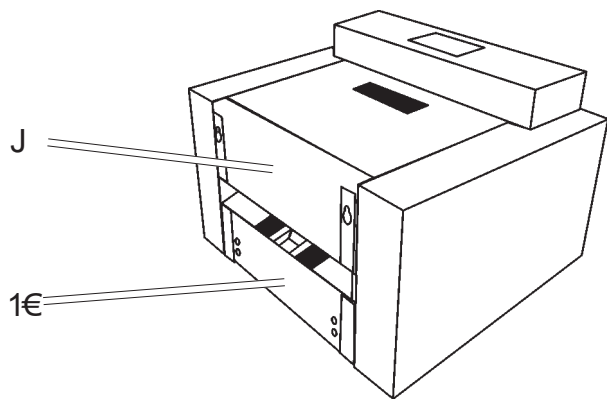
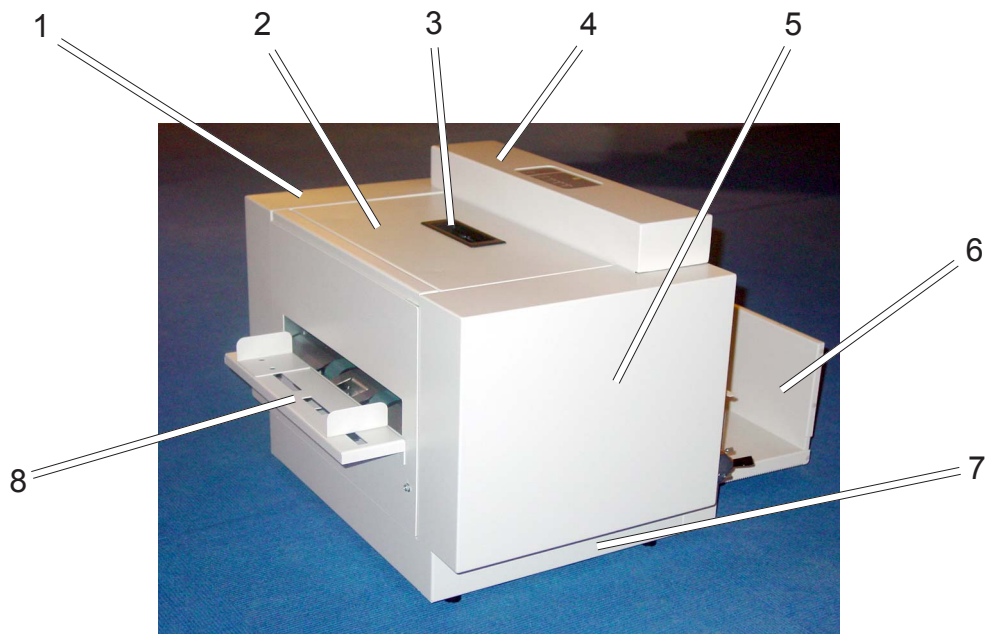

Covers

Item	Part no	Qty	Description	Notes
1	17220	1	Front Cover	
2	17221	1	Top Cover	
	17182	2	Hinge	
3	51059	1	Handle	
4	17233	1	Panel Cover	
5	17219	1	Rear Cover	
6	170118	1	Stacker Tray	
7	170122	1	Stand Offline	
8	170123	1	Hand Infeed Tray	
AA	17218	1	Infeed Cover	
1E	17217	1	Bottom Cover	
1F	17262	1	Upper Outfeed Cover	
1G	17299	1	Lower Outfeed Cover	

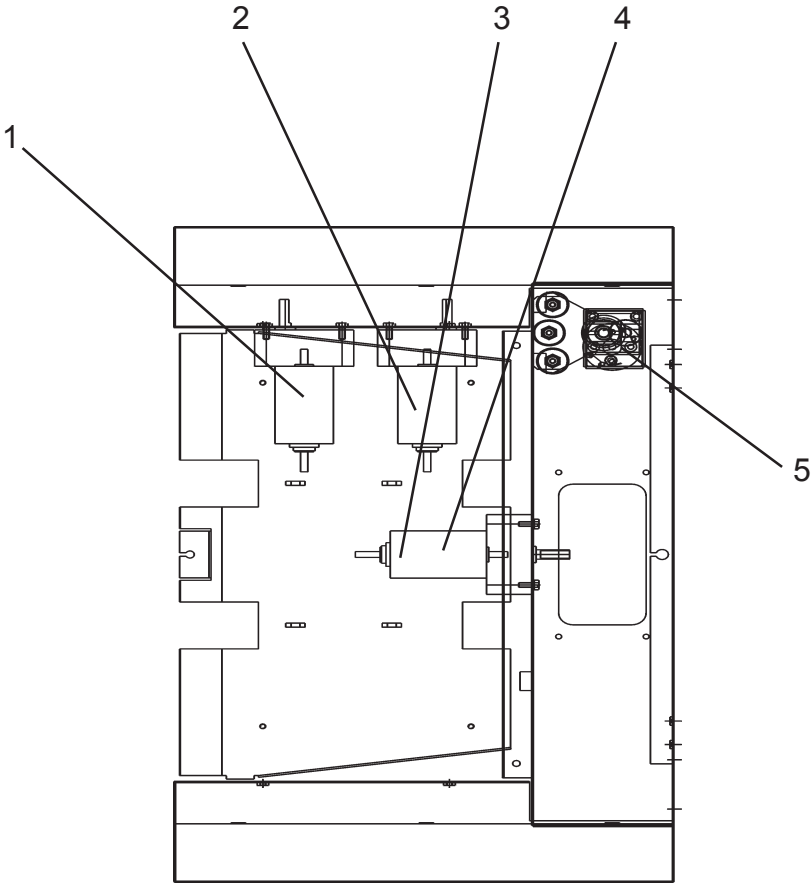

Motors

Item	Part no	Qty	Description	Note
1	171023	1	Transport Belt Motor M1	Before L104C00001
	171031	1	Transport Belt Motor M1	After L104C00001
2	171023	1	Stop Gate Motor M2	Before L104C00001
	171031	1	Stop Gate Motor M2	After L104C00001
3	171024	1	Clamp Motor M3	Before L104C00001
	171032	1	Cimap Motor M3	After L104C00001
4	171026	1	Brush kit	2 Brushes
5	171018	1	Roll Motor M4	Before L104C00001
	171033	1	Roll Motor M4	After L104C00001

Sensors

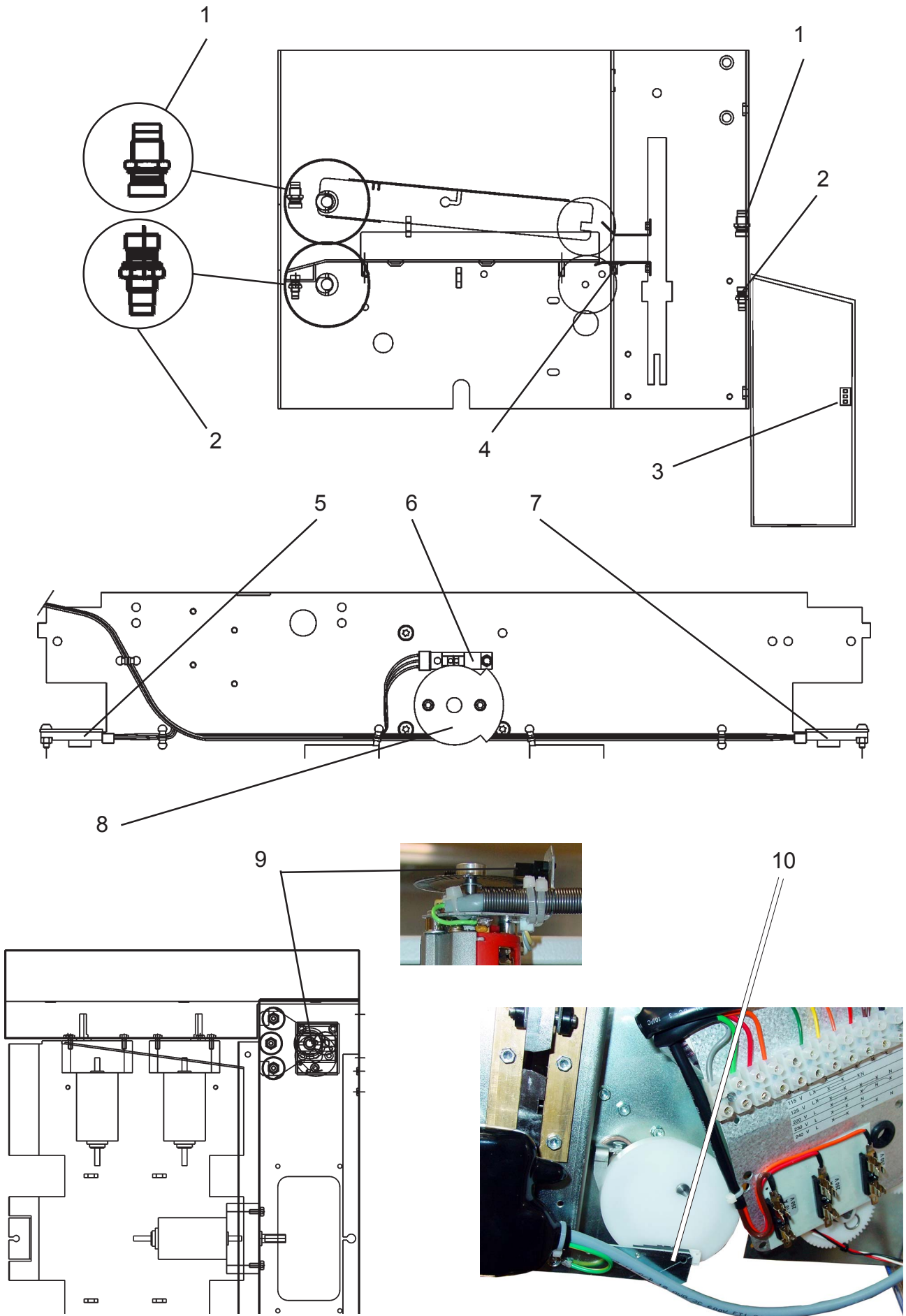

Sensors

Item	Part no	Qty	Description	Note
1	881008	2	LED assy	Q5, Q7
2	881009	2	Phototransistor assy	Q5, Q7
	171007	1	Sensor kit incl.	Item 1 and 2 Q5 & Q7
3	75512	1	Stacker Sensor	Q9
4	96133	1	Clamp Sensor	Q6
5	96133	1	Motor M4 Front Sensor	Q2
6	96133	1	Motor M3 Home Position Sensor	Q4
7	96133	1	Motor M4 front Sensor	Q3
8	17222	1	Encoder Disc	
9	45188	1	Rail Motor Sensor	Q8
10	96133	1	Stop Gate Limit Sensor	Q1

Interlock switches

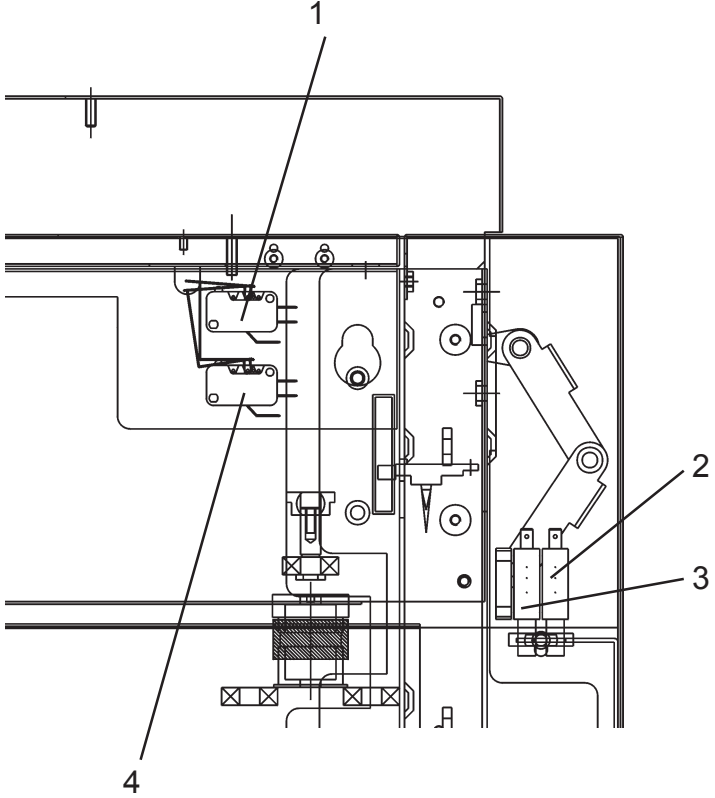

Interlock switches

Item	Part no	Qty	Description
1	171014	1	Interlock switch assy
2	171014	1	Interlock switch assy
3	171015	1	Interlock switch assy
4	171016	1	Interlock switch assy

Transport belts

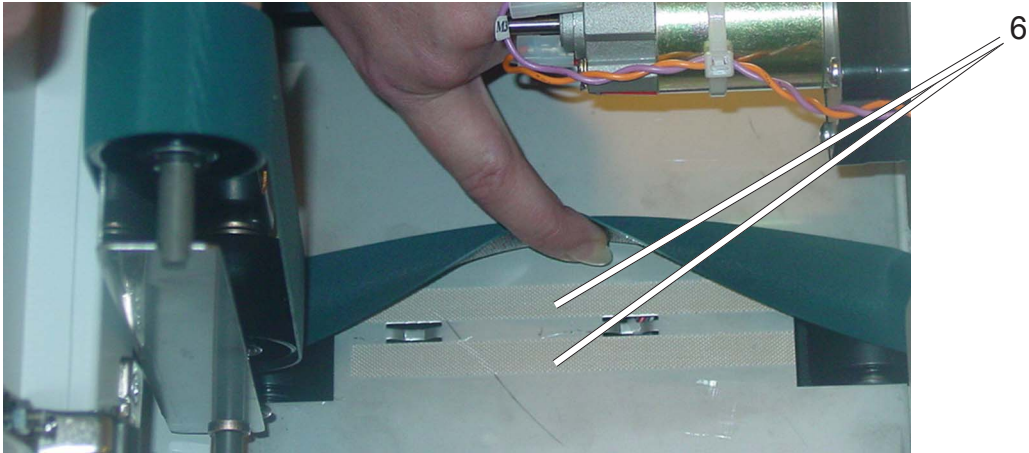
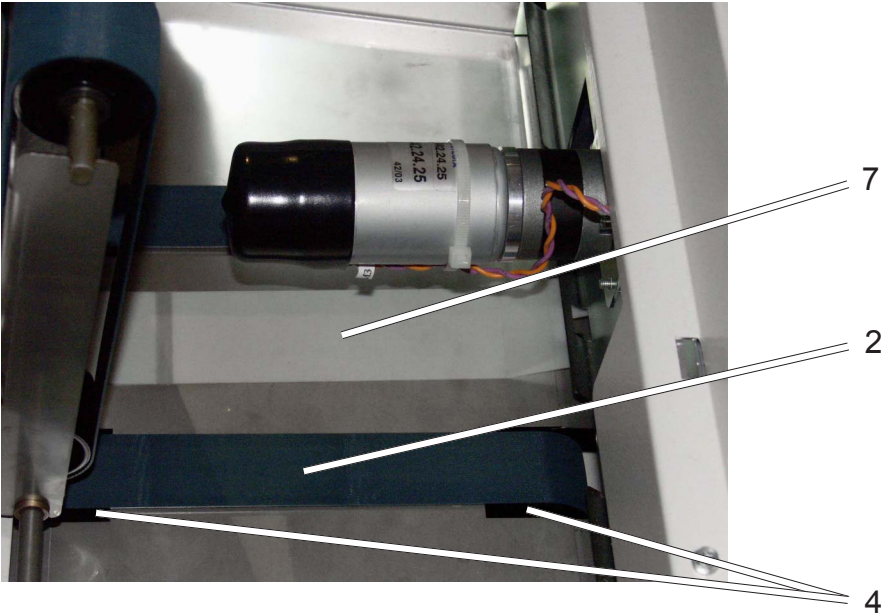
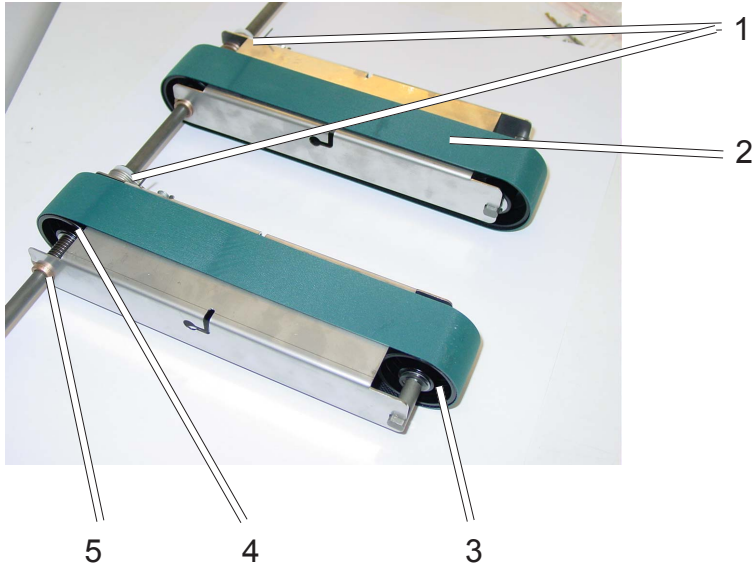

Transport belts

Item	Part no	Qty	Description	Note
1	17177	2	Spring	
2	17232	2	Belt Kit	One pair of belt
3	171006	2	Pulley assy	Incl. one one-way bearing
4	171005	2	Pulley assy	Incl pulley and 2 bearing
5	14448	4	R-clip	
	90210	2	Spring	
6	171019	4	Teflon Tape assy	One pair of straps
7	171049	1	Trim Strip Deflector	

Link arm assy front and rear

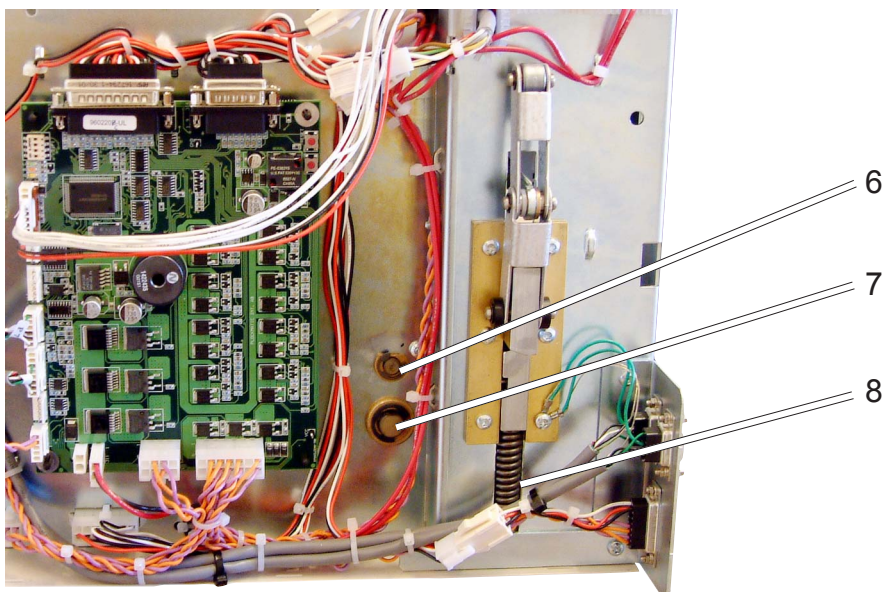
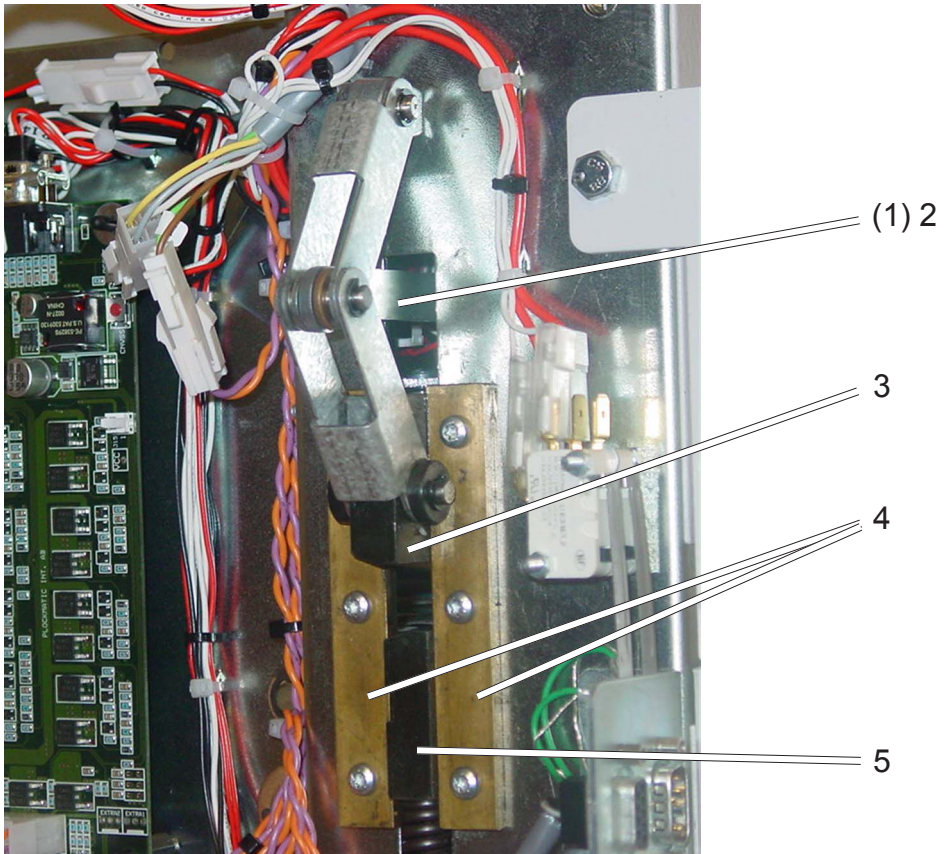
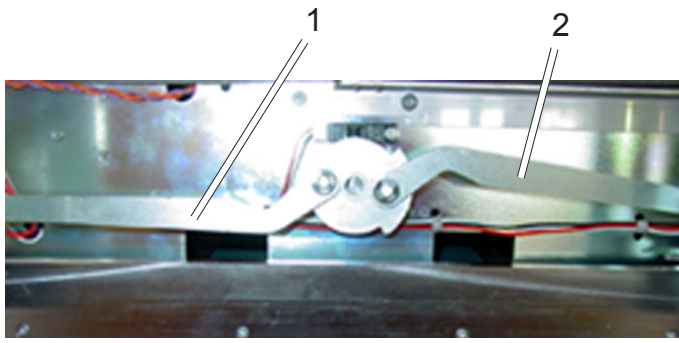

Link arm assy front and rear

Item	Part no	Qty	Description
(1)	171004	1	Link Arm assy. front
2	171003	1	Link Arm assy. rear
3	171009	1	Upper Clamp assy
4	17052	4	Bronze guides
5	171013	1	Lower Clamp assy
6	88993	1	Bushing
7	89599	2	Bushing
8	17178	2	Spring

Stop gate cam

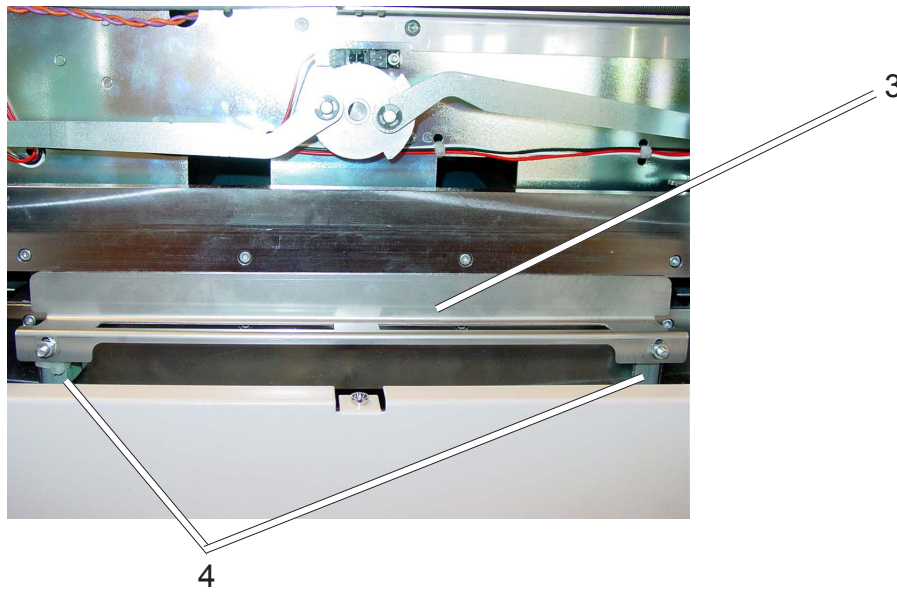
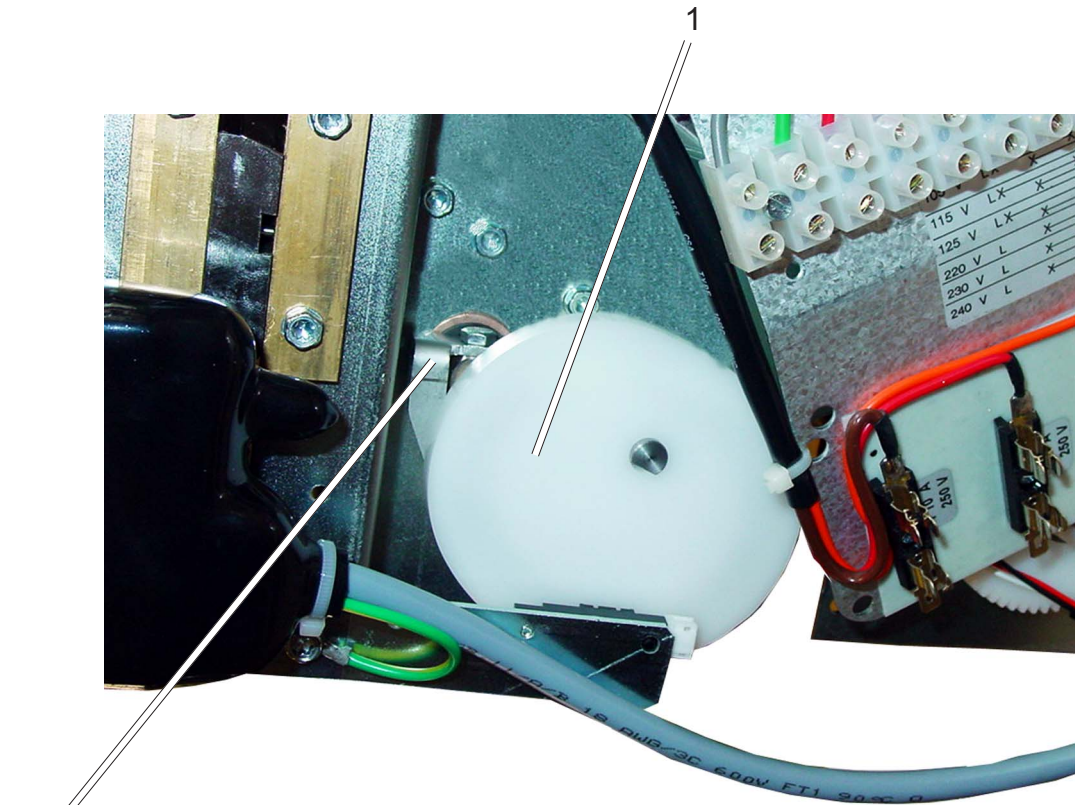

Stop gate cam

Item	Part no	Qty	Description	Note
1	171022	1	Cam assy	Incl. Cam, Bearing, Cam follower
2	17148	1	Cam follower	
3	170106	1	Stop gate Assy	Incl. 171002
4	171002	1	Damper assy	2 pcs.

Roll motor

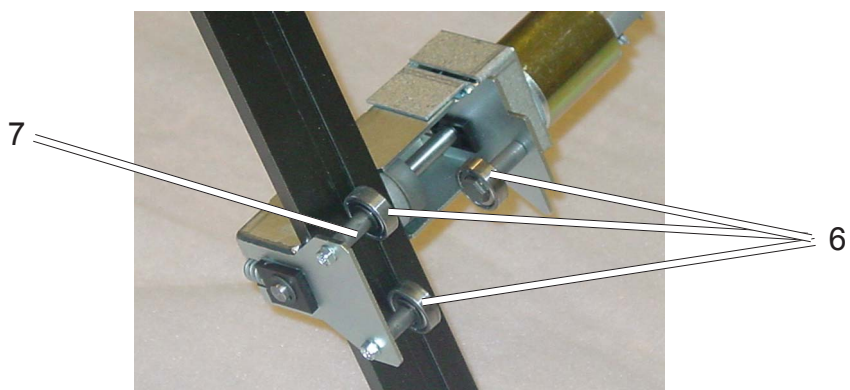
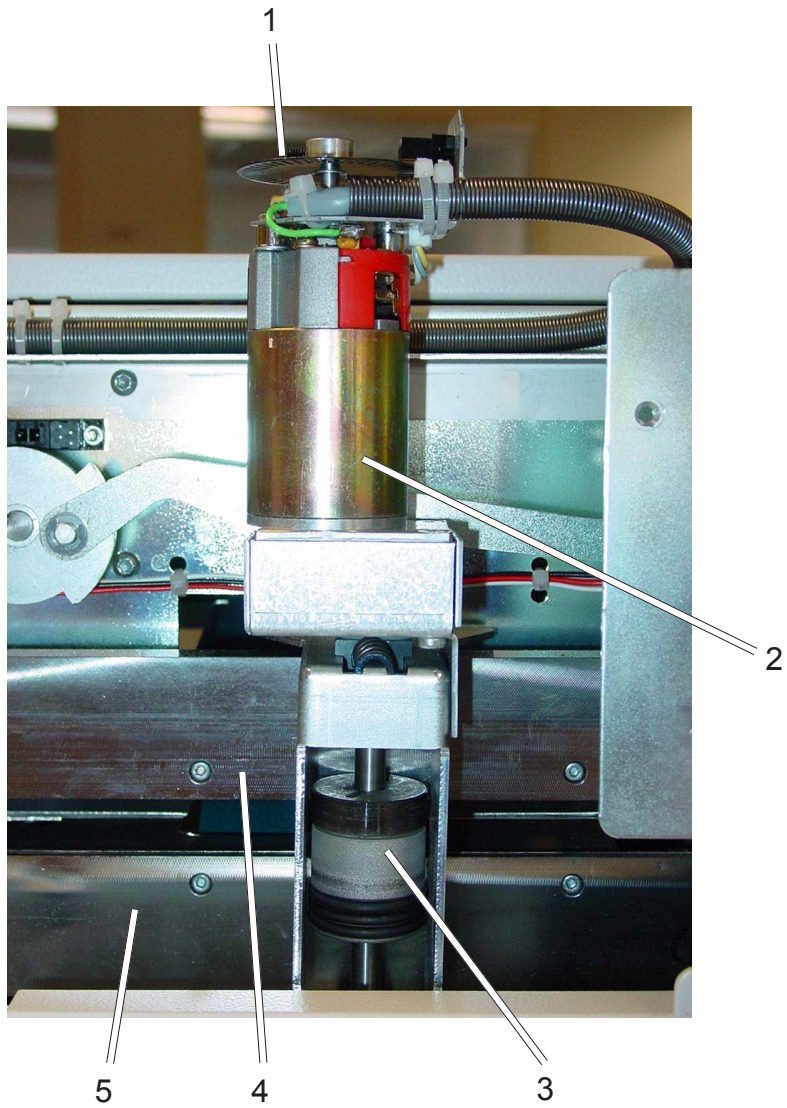

Roll motor

Item	Part no	Qty	Description	Note
1	171017	1	Tacho disc	
2	171018	1	Roll Motor M4 Assy	Incl. Cables
3	171010	1	Pressure Roll Assy	Incl. O-rings
4	171009	1	Upper Clamp Assy	
5	171013	1	Lower Clamp Assy	
6	30559	3	Bearing	
7	17259	3	Bearing Shaft	

Electrical components

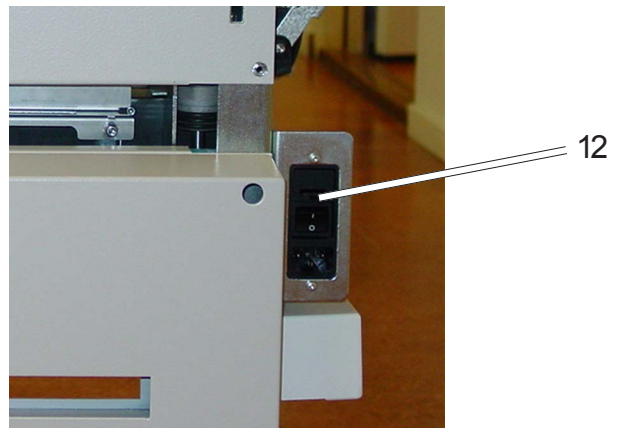
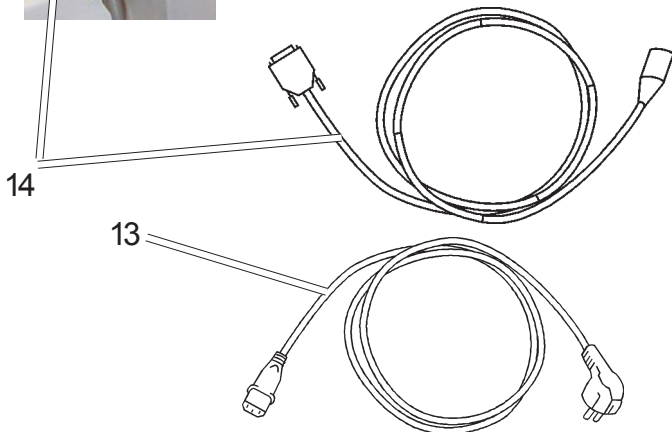
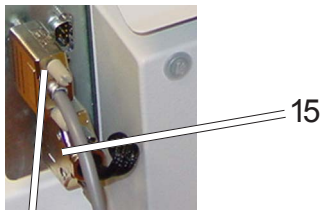
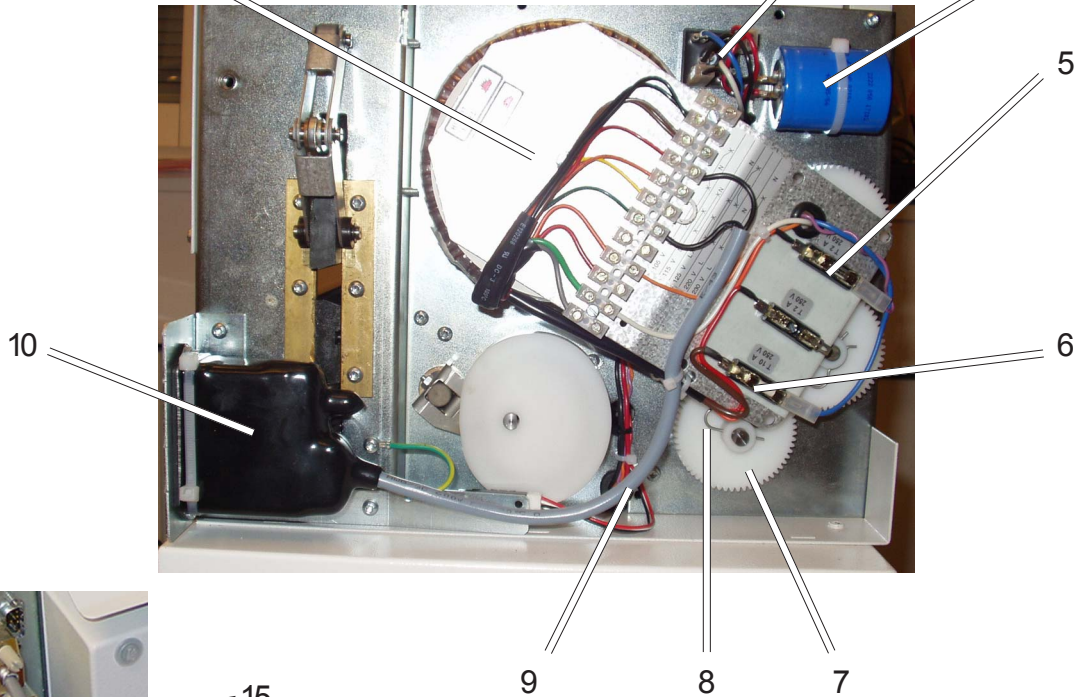
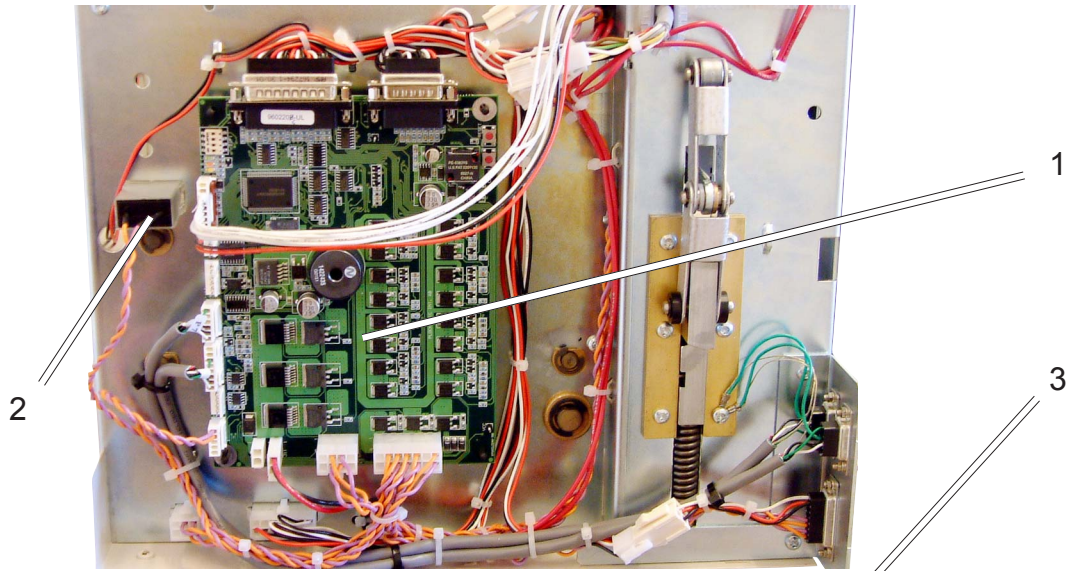

Electrical components

Item	Part no	Qty	Description	Note
1	171020	1	PCB MD6DC	
2	47067	1	Counter	
3	20711	1	Rectifier	
4	90517	1	Capacitor	
5	88549	1	Fuse F2, T2A	
6	90605	1	Fuse F1, T10A	
7	17087	3	Gear	
8	17210	3	R-Clip	
9	170209	1	Power supply Harness	
10	45155	1	Receptacle	With filter excl. 88554
	88554	1	Fuse holder	
	45214	1	Plastic Sleeve	
11	90178	1	Transformer	
12	60651	1	Fuse F3 3.15A	230V
	12754	1	Fuse F3 6.3A	115V
13	87157	1	Power Cord	USA
14	170226	1	Connection Cable	PL104-Trimmer
15	170225	1	Stacker Sensor Cable Assy	

Control panel

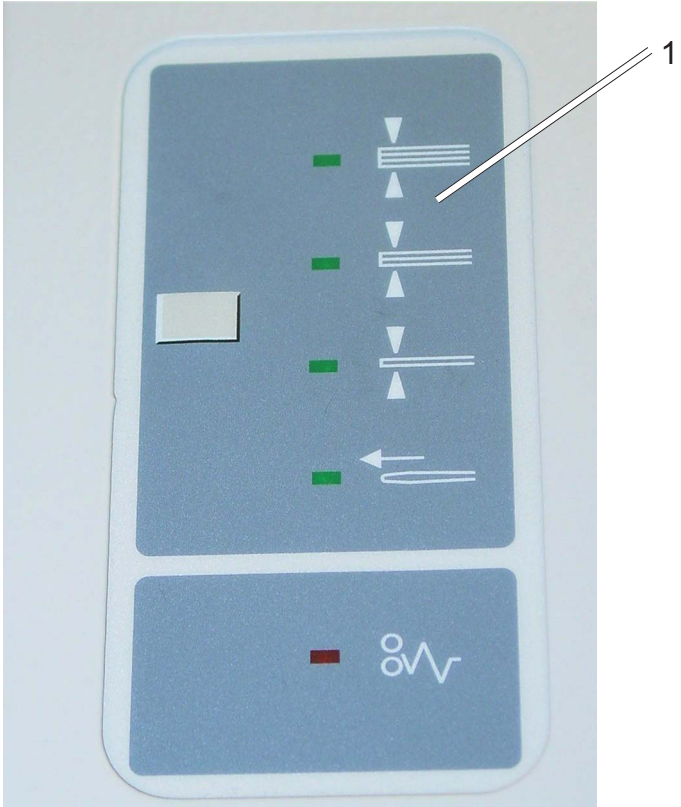

Control panel

Item	Part no	Qty	Description	Note
1	17139	1	Panel overlay	
	171011	1	Panel Kit	Incl. Overlay and Panel PCB